

### Product Summary:

In collaboration with the Vision X engineering team, the Imtra Offshore Series Marine LED Deck Lights are specifically designed with the extra protections required to survive life on the open ocean. The stainless-steel brackets, copper circuit boards, tinned extra-long sheathed cables and marine-grade gloss coating are all there to protect the fixture from corrosion and other harmful elements encountered on the water. Additional safeguards such as EMC shielding and transient voltage suppression set these fixtures far above our competition. Each model is available in several beam angle configurations from narrow to extra wide flood. We also offer elliptical beam options for side deck applications.



### Package Contents:

- (1) OFS 5LED light fixture with mounting bracket installed
- (3) Hex Head M10 mounting bolt
- (3) Metal Washer
- (3) Nylon Locking Nut
- (3) Isolating PC Spacer Kits

### Tools Required For Assembly

- 13mm Wrench / Socket OR Philips-Head Screwdriver
- 17mm Wrench
- 17mm Socket Wrench
- Drill with 9/16" size drill bit (if mounting hole is needed)



**PLEASE READ ALL INSTRUCTIONS BEFORE INSTALLATION**



### Safety Instructions:



**WARNING: RISK OF ELECTRIC SHOCK**

- Installation is intended to be done by a qualified electrician in accordance with the control of hazardous energy (lockout/tagout) safety regulations and procedures.
- Installation must follow the NEC/ABYC/USCG electrical codes set for the specific vessel the fixture is being installed on.
- Ensure **ALL POWER SOURCES** connected to the room or fixture location are turned **OFF** before installation.
- Verify input voltage is within fixture range before installation.
- The use of safety equipment (safety glasses and gloves) are highly recommended.
- Avoid mounting near any combustible material and/or heating units.
- Any maintenance/repairs to the fixture may only be carried out by a qualified electrician.
- Allow proper cooling time before handling the fixture if it has been installed & powered.
- Any modifications to the fixture will automatically void warranty.
- Always inspect the fixture for any damage prior to installing and **DO NOT** install if any damage is present.

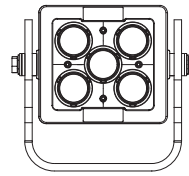

**Fixture Dimensions:**

2D Front and Side View (mm/in.)

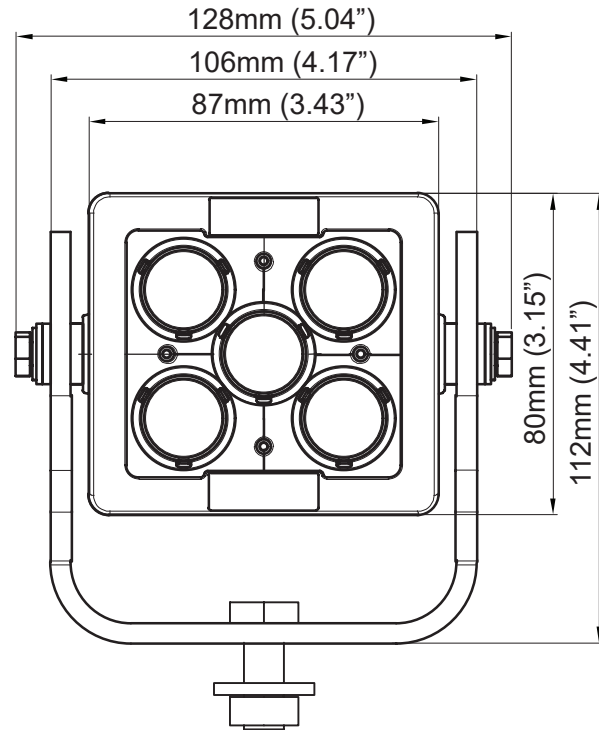
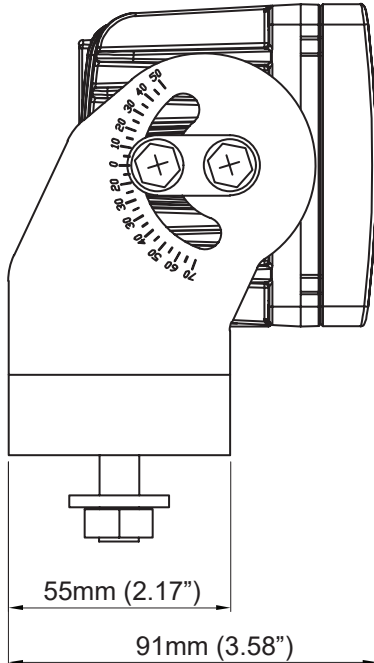

**Specifications & Certifications:**

Technical Information

<b>Housing Finish/Material</b>	White or Black Anodized Die-Cast Aluminum
<b>Bracket</b>	304 Stainless Steel
<b>Lens Material</b>	Polycarbonate
<b>Input Voltage</b>	11-65VDC
<b>Power Consumption</b>	35W (7W per LED)
<b>Luminous Flux</b>	4,400 (raw) 3,305 (effective)
<b>Correlated Color Temperature (CCT)</b>	5700K
<b>Beam Angle</b>	10°, 25°, 30/65°, 40°, 60°, 90°
<b>Ingress Protection</b>	IP68/IP69K
<b>Protections</b>	CISPR 25 - Class 1
<b>Certifications &amp; Compliance</b>	CE, ROHS, IEC 6247
<b>Warranty</b>	5 Years

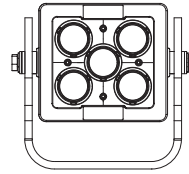

**Fixture Mounting Template:**  
To Scale 2D Bottom View (mm/in.)

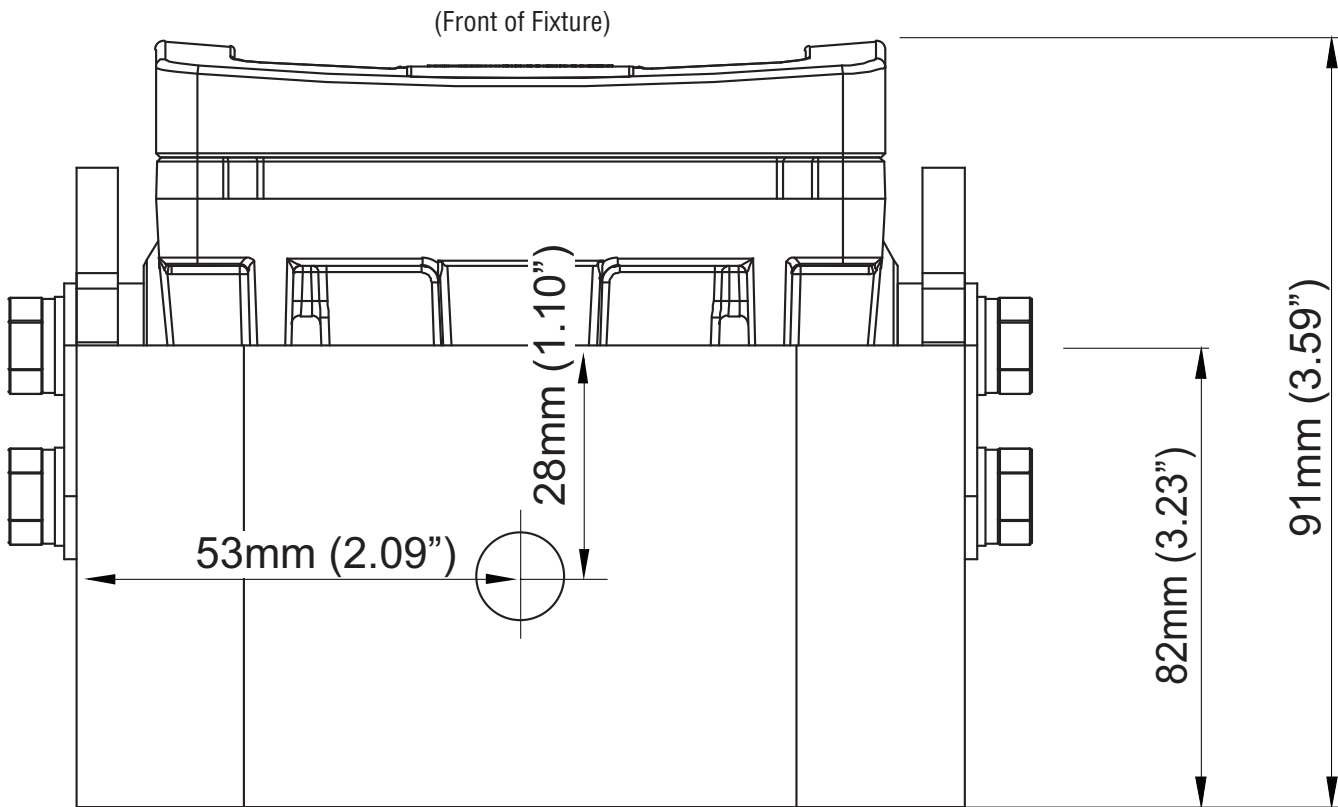

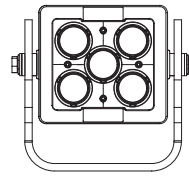

### Fixture Mounting Instructions:

#### Isolation Kit Assembly

#### Tools Required For Assembly

- 17mm Wrench
- 17mm Socket Wrench
- Drill with 9/16" size drill bit (if mounting hole is needed)

#### Note:

Diagram depicts using a single bolt mounting. The isolation assembly is the same if using 2 or 3 bolt mounting.

Isolation Assembly Diagram:

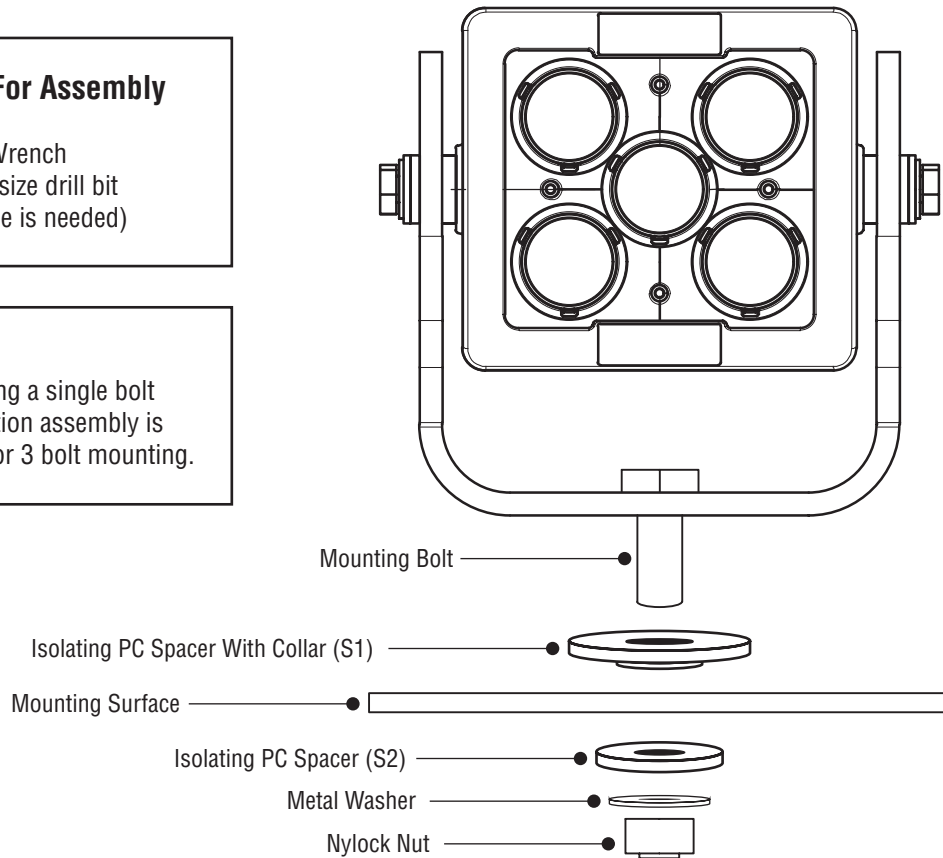

**WARNING:** Bolts, Nuts, and Washers are Stainless Steel. **DO NOT USE** Pneumatic or Electric Tools to Tighten and Loosen. The **Hardware Will Permanently Seize Together.**



### Recommendations:

- For all threaded fasteners we recommend using Loctite LB 8023™ Marine Grade Anti-Seize.
- Coat under the top of the bolt head as well as the entire bottom end of the bolt thread where the nut will be threaded on.

### Mounting Instructions:

- Find suitable location for the light fixture and mark mounting hole location using the provided template if drilling is needed.
- Allow for ~25mm around the housing on all sides to permit convective cooling of the heat sink. Flush mounting is not permitted and will void warranty.
- Drill a 9/16" hole to accommodate the PC Spacer With Collar (S1) into mounting surface.
- Use PC Spacer (S2) between mounting surface and metal washer.
- Thread on Nylon Locking Nut
- Using a 17mm wrench to hold the hex head bolt and a 17mm socket for the nut, tighten down to secure.

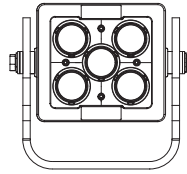

## Fixture Aiming Instructions:

### Beam Angle Adjustment

#### Tools Required For Assembly

- 13mm Wrench/Socket **OR**
- Philips-Head Screwdriver

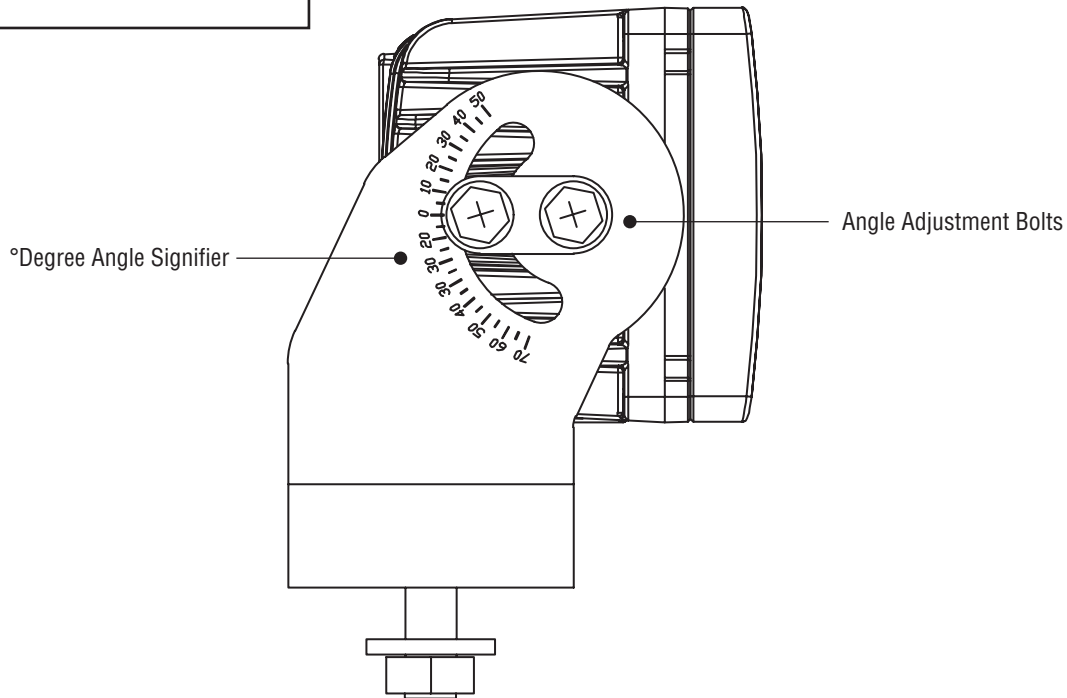

WARNING: Bolts, Nuts, and Washers are Stainless Steel. **DO NOT USE** Pneumatic or Electric Tools to Tighten and Loosen. The **Hardware Will Permanently Seize Together.**



## Light Angle Adjustment Instructions:

- Loosen (do not remove) all 4 fixture Angle Adjustment Bolts located on both sides of the fixture using a 13mm Wrench/Socket or Philips-Head Screwdriver.
- With the fixture loose from the mounting bracket, adjust the fixture up or down to the desired aiming angle. Note the degree angle is on the bracket if specific degree angle is needed.
- Re-tighten the 4 side Angle Adjustment Bolts.

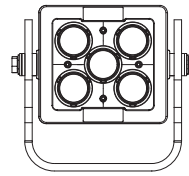

### Fixture Wiring Instructions:

Wire Functions / Drip & Service Loop / Cable Gland

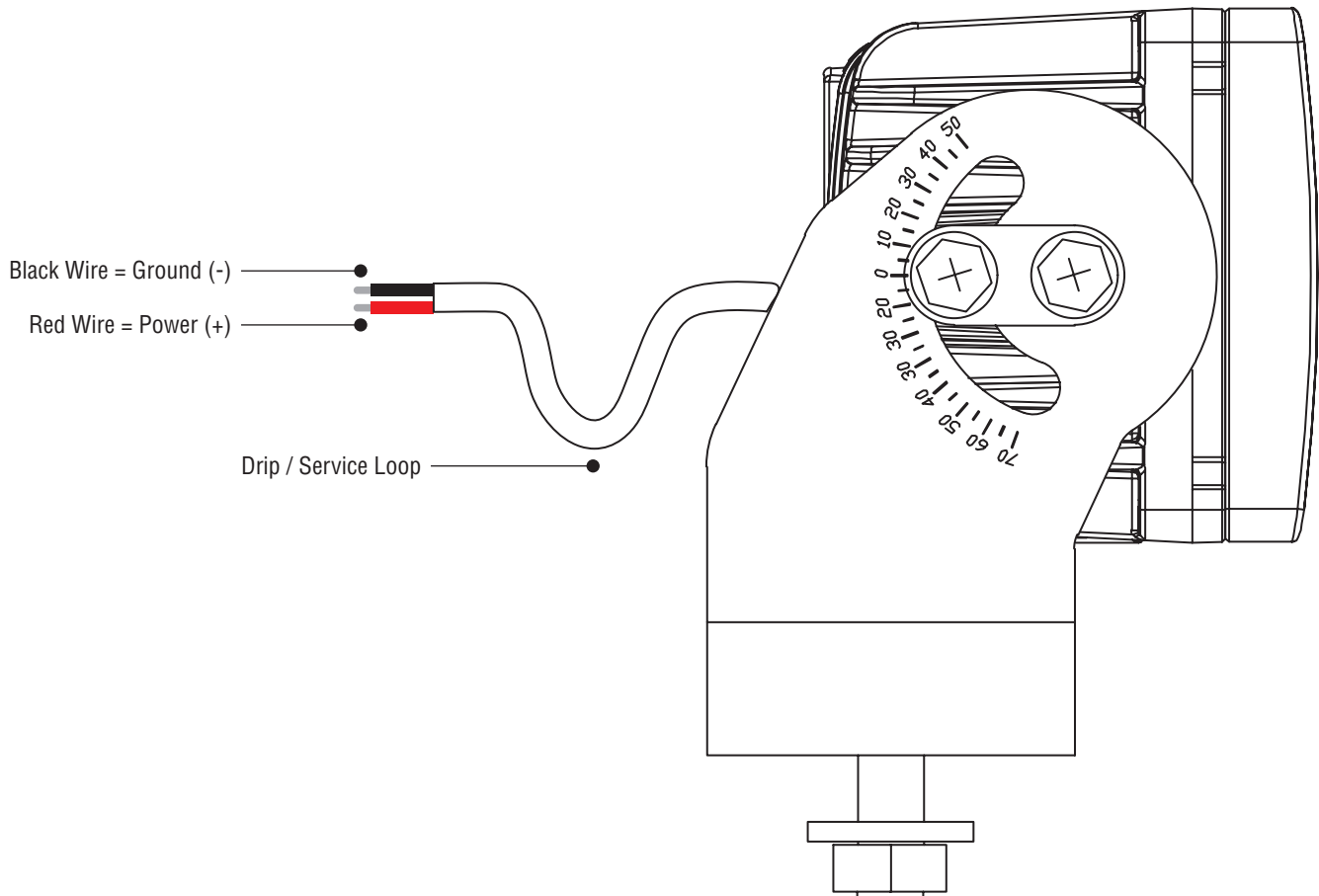

### Recommendations:

- A Drip / Service loop should be used to ensure water does not run down the wire towards the fixture as well as provide adequate space for the fixture to move if removal or service is required.
- A waterproof cable gland should be used where the cable passes into the vessel to ensure a watertight seal.

### Wiring Instructions:

- Supplied with the fixture is 6' x 16awg duplex boat cable lead with 2 raw wires showing.
- Connect the Red Wire (+) to your DC power source using proper electrical connectors.
- Connect the Black Wire (-) to your grounding source.
- Follow ABYC wire sizing recommendations for no more than 3% voltage drop in 12V installations and no more than 10% voltage drop in 24V installations.
- It is highly recommended to operate 12LED and 20LED models at 24V. Please consult a qualified marine electrician or IMTRA for 12V to 24V DC to DC converters.
- Test fixture.

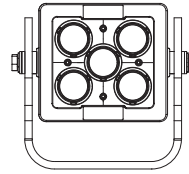

**Warranty Information:**

Rules and Regulations

 <p><b>imtra</b> CORPORATION</p>	<p><b>5-YEAR</b> LIMITED WARRANTY</p>
-----------------------------------------------------------------------------------------------------------------------	-------------------------------------------

**Rules and Regulations:**

- Proof of purchase is required to validate warranty and is valid from the original date of purchase. All products must be bought through Imtra Corp., an Imtra Corp. Authorized Dealer, or one of their dealers/resellers.
- Improper installation, accident, physical damage, neglect, and normal wear are not covered under warranty.
- Lights operated in environments over 150° Fahrenheit are not covered under warranty.
- Warrantied items will be repaired to working condition and returned without cosmetic alterations.
- Warranties should be handled through the dealer/reseller the product was purchased from; customer is responsible for delivery.
- If product is not under warranty, customers will be responsible for return shipping charges.
- Additionally, non-warranted items can be repaired at the customer's expense of parts and labor, at the discretion of Imtra Corp., who will provide an estimated repair cost before proceeding with the repair.

**Installer Notes:**

---



---



---



---



---



---



---



---



---



---



---