

### Product Summary:

In collaboration with the Vision X engineering team, the Imtra Linear Series Marine LED Lights are specifically designed with the extra protections required to survive life on the open ocean. The stainless-steel brackets, copper circuit boards, tinned extra-long sheathed cables and marine-grade gloss coating are all there to protect the fixture from corrosion and other harmful elements encountered on the water. Additional safeguards such as EMC shielding and transient voltage suppression set these fixtures far above our competition. Each Linear features a 180° ultra wide beam pattern for maximum coverage.



### Package Contents:

- (1) Linear light fixture
- (2) Stainless Steel Mounting Brackets and Hardware

### Tools Required For Assembly

- Philips Head or Flat Head Screwdriver
- 3mm Allen Key
- 2.5mm Allen Key
- Adjustable Wrench



PLEASE READ ALL INSTRUCTIONS BEFORE INSTALLATION



### Safety Instructions:



**WARNING: RISK OF ELECTRIC SHOCK**

- Installation is intended to be done by a qualified electrician in accordance with the control of hazardous energy (lockout/tagout) safety regulations and procedures.
- Installation must follow the NEC/ABYC/USCG electrical codes set for the specific vessel the fixture is being installed on.
- Ensure **ALL POWER SOURCES** connected to the room or fixture location are turned **OFF** before installation.
- Verify input voltage is within fixture range before installation.
- The use of safety equipment (safety glasses and gloves) are highly recommended.
- Avoid mounting near any combustible material and/or heating units.
- Any maintenance/repairs to the fixture may only be carried out by a qualified electrician.
- Allow proper cooling time before handling the fixture if it has been installed & powered.
- Any modifications to the fixture will automatically void warranty.
- Always inspect the fixture for any damage prior to installing and **DO NOT** install if any damage is present.

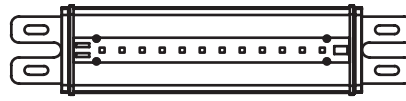

## Fixture Dimensions:

2D Top and Side View (mm/in.)

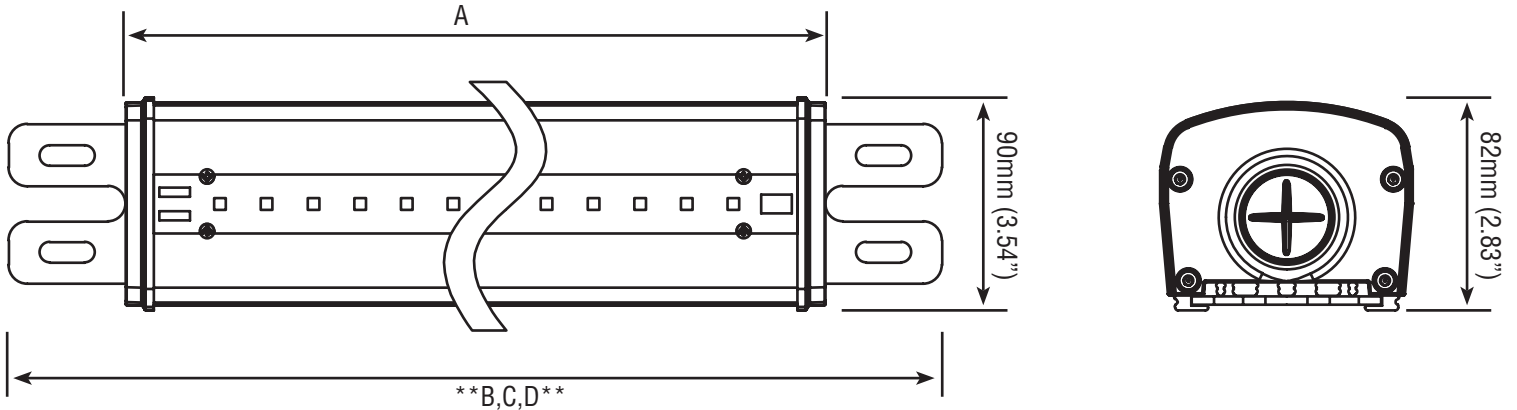

**\*\*NOTE:** The Mounting Brackets Are Adjustable with 3 Available Positions (B,C,D) and Change the Overall Mounting Length.\*\*

MODEL	A	B	C	D
2 Foot Linear	600mm (23.62")	699mm (27.50")	727mm (28.62")	759mm (29.87")
4 Foot Linear	1200mm (47.24")	1298mm (51.12")	1,327mm (52.24")	1,359mm (53.49")

## Specifications & Certifications:

### Technical Information

<b>Housing Finish/Material</b>	Blue Powder Coated Die-Cast Aluminum
<b>Bracket</b>	304 Stainless Steel
<b>Lens Material</b>	Polycarbonate
<b>Input Voltage</b>	110-277VAC
<b>Power Consumption</b>	2ft. 60W   4ft. 120W
<b>Luminous Flux</b>	2ft. 7,800   4ft. 13,400
<b>Correlated Color Temperature (CCT)</b>	5000K
<b>Beam Angle Options</b>	180°
<b>Ingress Protection</b>	IP67
<b>Protections</b>	CISPR 25 - Class 1
<b>Certifications &amp; Compliance</b>	CE, ROHS, IEC 6247, UL1598
<b>Warranty</b>	5 Years

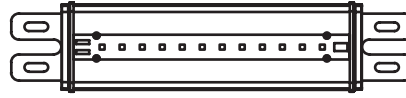

### Fixture Mounting Instructions:

Bracket installation and Mounting

#### Tools Required For Assembly

- 2.5mm Allen Key

Mounting Brackets Install Diagram (Back View)

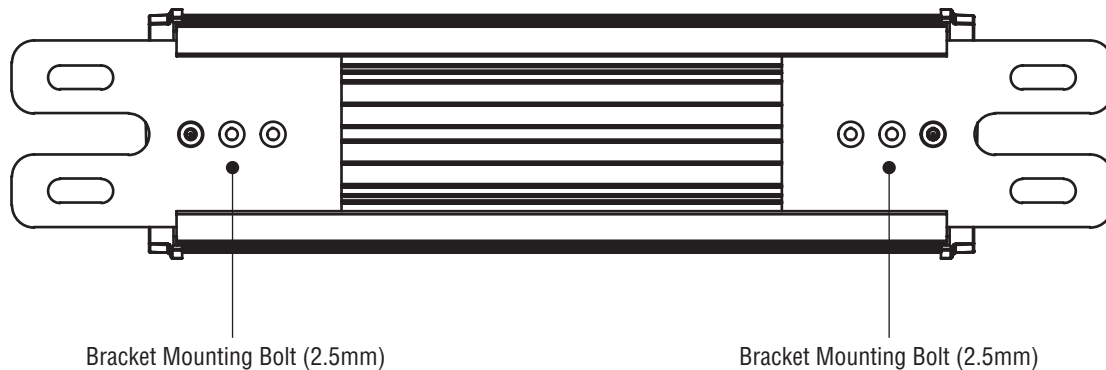

WARNING: Bolts, Nuts, and Washers are Stainless Steel. **DO NOT USE** Pneumatic or Electric Tools to Tighten and Loosen. The **Hardware Will Permanently Seize Together.**



### Recommendations:

- For all threaded fasteners we recommend using Loctite LB 8023™ Marine Grade Anti-Seize.
- Coat under the top of the bolt head as well as the entire bottom end of the bolt thread where the nut will be threaded on.

### Installing Mounting Brackets:

- Supplied with the fixture is (2) stainless steel mounting brackets and (2) 2.5mm allen head bolts.
- Slide the mounting brackets into the slots on each side of the fixture making sure that the side with the counter-sunk holes is facing away from the fixture.
- The 3 holes on the mounting brackets allow you to slide/adjust the brackets in or out to accommodate your mounting length.
- Once the length desired is achieved, thread in the mounting bracket bolt using a 2.5mm allen key to secure.

### Mounting Instructions:

- Find a suitable flat location for the light fixture and mark mounting hole location if drilling is needed.
- Secure fixture to mounting location utilizing the (4) mounting slots on the mounting brackets.



### Fixture Wiring Instructions:

Wire Functions / Drip & Service Loop / Cable Gland

#### Tools Required For Assembly

- Flat Head or Philips Head Screwdriver
- 3mm Allen Key
- Adjustable Wrench

### End Cap Wiring Access Diagram

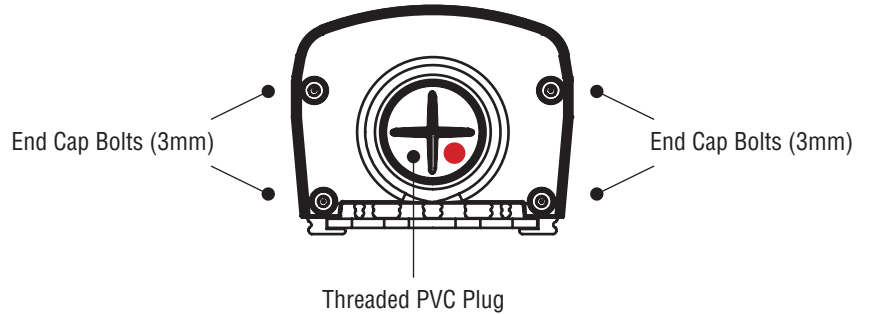

**NOTE:** The light fixture side with the red dot located on the threaded PVC plug indicates the side for wiring.

### Wiring Preparation Instructions:

- In order to begin wiring, the end cap must first be removed. Using a 3mm Allen, remove the 4 end cap bolts and remove the end cap assembly.
- With the end cap assembly removed, remove the PVC plug using a philips / flat head screwdriver.
- Included behind the PVC plug is an O-Ring. Ensure that it remains properly seated into the end cap assembly before continuing.
- Thread on the provided cable gland to the end cap assembly and secure using an adjustable wrench.

### America Wire Definitions:

Wire Functions

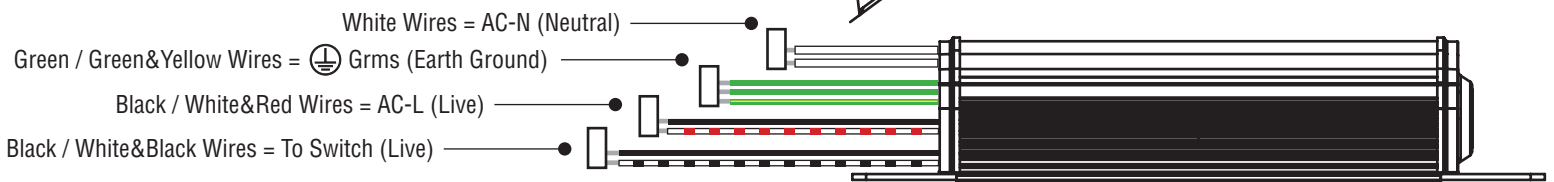

### Europe Wire Definitions:

Wire Functions

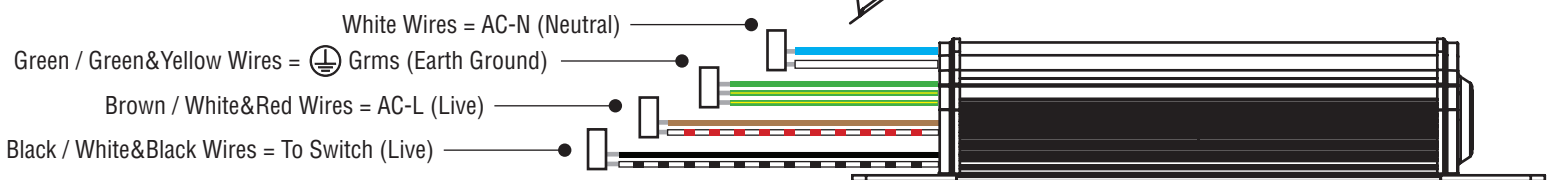



### Fixture Wiring Instructions:

Wire Functions / Drip & Service Loop / Cable Gland

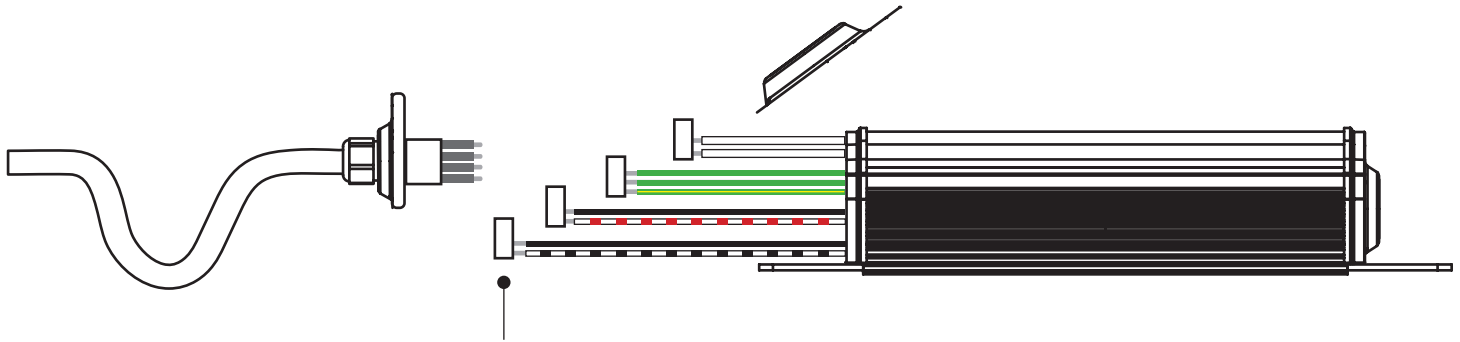

**NOTE:** The light fixture will come standard with proper Wago electrical connectors already attached and ready for install.

### Wiring Instructions:

- With the cable gland installed, feed the source wiring through the cable gland and end cap assembly to begin wiring.
- Connect the Black / White&Red or Brown / White&Red Wires (AC-L) to your Live AC power source using proper electrical connectors.
- Connect the White / White or Blue / White Wires (AC-N) to your neutral circuit using proper electrical connectors.
- Connect the Green and Green/Yellow Wires (⊕ Earth Ground) to your grounding source using proper electrical connectors.
- Once all connections are made, tuck the wiring back into the fixtures housing and re-install the end cap assembly.
- Tighten down the cap portion of cable gland using an adjustable wrench to ensure a water-tight seal.
- Test Light.

### Battery Back-up Instructions:

Connections / Testing

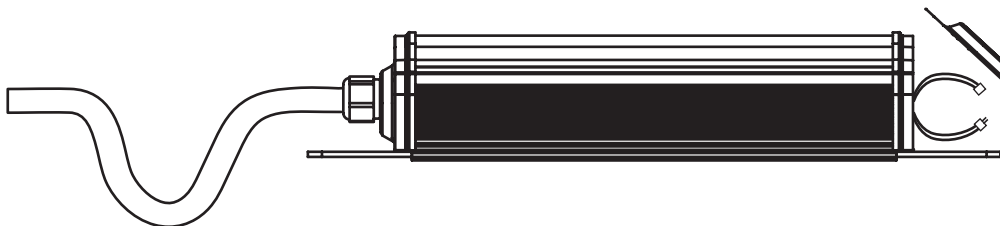

### Wiring Instructions:

- On the opposite side of the light fixture, remove the 4 bolt end cap assembly using a 3mm Allen Key.
- With the end cap removed you will notice matching 2-Pin male and female connectors. These are for the battery back-up system.
- Push the connectors together to enable the battery back-up system.
- To test, remove the PVC plug from the end cap assembly using a philips / flat head screwdriver to expose the red push button.
- With the red button pushed down the light fixture should now be on at 50% brightness.
- Re-install the end cap assembly and PVC plug back onto the light fixture.

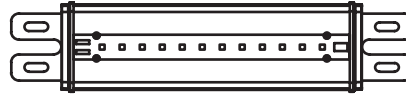

### Fixture Wiring Instructions:

#### Drip Service Loop

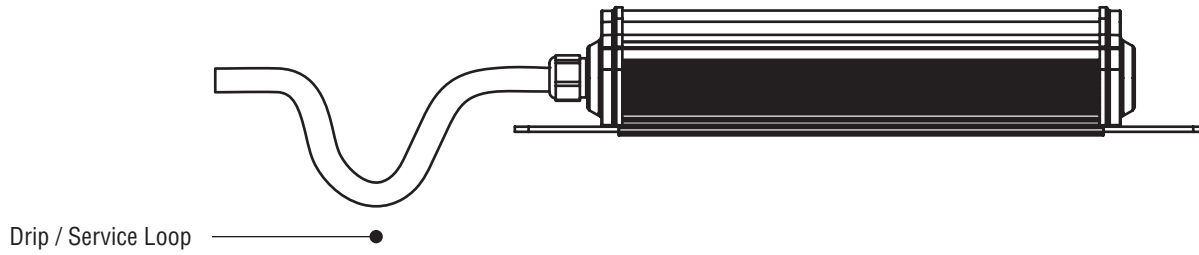

### Recommended Drip/Service Loop

- A Drip / Service loop should be used to ensure water does not run down the wire towards the fixture as well as provide adequate space for the fixture to move if removal or service is required.
- A waterproof cable gland should be used where the cable passes into the vessel to ensure a watertight seal.

